

drive.web **smarty**®

Universal Automation Controller

models

**dw240, dw241,
dw244,
dw248, & dw249**



Installation & Operation Manual

Contents	Page
UL, CE, and UKCA Conformity Statements, Warnings smarty Models, Standard Features	1, 2 2
smarty Installation, Terminal Naming and Ratings	3, 4
smarty Terminals and Wiring, Front Panel, Serial Port	5
smarty Carrier Descriptions	6
Carrier Terminal Designations, Dimensions, Drawings	7-10
smarty Extended Operating Ranges, RTC clock, FI Notes	11
Get savvy®, USB Plug and Play, Ethernet Networking	12, 13
Get started with savvy engineering & design software	13, 14
Upgrade savvy and smarty, savvy-SFD Upgrade	14
smartyPanel® Touch Screen Operator Station	14, 15
smarty Precision Motion Parameters and Connections	12
smarty Comms Interfaces, CANopen, Modbus, EIP	12
Free drive.web Online Training Seminars	12



UL Certification Statements

This process control equipment to be supplied by Class2, LPS, limited power supply.

CE and UKCA Conformity Statements

EMC Standard, EN 61326-1: 2006, Electrical Equipment for Measurement, Control and Laboratory Use.

Emissions Class A, Commercial Equipment.

Immunity Table 2, Industrial Equipment.

LVD Standards, EN 61010-1: 2010, Safety Requirements for Electrical Equipment for Measurement, Control and Laboratory Use and;

EN 61010-2-030: Particular Requirements for Testing and Measuring Circuits.

smarty is an industrial controller designed for permanent installation by qualified professionals.

If it is used in a manner not specified herein the protection provided may be impaired.

smarty and its packaging contain recyclable materials

This device is designed to comply with Part 15 of the FCC Rules. Operation is subject to the following two conditions: (1) This device may not cause harmful interference, and (2) this device must accept any interference received, including interference that may cause undesired operation.

This Class [A] digital apparatus is designed to comply with Canadian ICES-003. Cet appareil numérique de la classe [A] est conforme à la norme NMB-003 du Canada.

Warning! It is essential that you read and understand this entire manual and the entire contents of the **savvy** software **Help** menu before proceeding with your installation and configuration. See page 6 for **savvy** installation instructions. For more information and to download manuals and software, go to www.driveweb.com or contact us. See page 12.

Warning! Your use of **savvy** software and **drive.web** devices may cause motors and machinery to power up with high Voltages or start or operate in an unexpected, dangerous or lethal way. It is essential that you are completely familiar with all of the equipment and the system design before attempting to program or edit a program or connect to any live device. It is also essential that a risk assessment is conducted to identify hazards. Risks must be reduced to tolerable levels.

Warning! You are entirely responsible for the configuration or use of any **drive.web** product. By configuring or using these products you agree to indemnify and hold harmless Bardac Corporation, its employees, directors, officers, distributors, and resellers against the consequences of your configuration or use of the products.

Warning! Information in this manual is subject to change without notice. You are responsible for verifying the proper operation of your **smarty**. Special care must be taken after loading new firmware or installing new options.

SMARTY, SAVVY, SAVVYPANEL, SPEEDY, BARDAC, and DRIVE.WEB are trade marks of Bardac Corporation, registered in the U.S. and other countries.

Warning! Avoid permanent damage to your **smarty**, never exceed any **min** or **max** values. Do not connect any **smarty** terminal to mains circuits. See page 5 for IO ratings.

lvIP is incorporated into **smarty** firmware. lvIP Copyright (c) 2001-2004 Swedish Institute of Computer Science. All rights reserved. Redistribution and use in source and binary forms, with or without modification, are permitted provided that the following conditions are met:

1. Redistributions of source code must retain the above copyright notice, this list of conditions and the following disclaimer.
2. Redistributions in binary form must reproduce the above copyright notice, this list of conditions and the following disclaimer in the documentation and/or other materials provided with the distribution.
3. The name of the author may not be used to endorse or promote products derived from this software without specific prior written permission.

THIS SOFTWARE IS PROVIDED BY THE AUTHOR "AS IS" AND ANY EXPRESS OR IMPLIED WARRANTIES, INCLUDING, BUT NOT LIMITED TO, THE IMPLIED WARRANTIES OF MERCHANTABILITY AND FITNESS FOR A PARTICULAR PURPOSE ARE DISCLAIMED. IN NO EVENT SHALL THE AUTHOR BE LIABLE FOR ANY DIRECT, INDIRECT, INCIDENTAL, SPECIAL, EXEMPLARY, OR CONSEQUENTIAL DAMAGES (INCLUDING, BUT NOT LIMITED TO, PROCUREMENT OF SUBSTITUTE GOODS OR SERVICES; LOSS OF USE, DATA, OR PROFITS; OR BUSINESS INTERRUPTION) HOWEVER CAUSED AND ON ANY THEORY OF LIABILITY, WHETHER IN CONTRACT, STRICT LIABILITY, OR TORT (INCLUDING NEGLIGENCE OR OTHERWISE) ARISING IN ANY WAY OUT OF THE USE OF THIS SOFTWARE, EVEN IF ADVISED OF THE POSSIBILITY OF SUCH DAMAGE.

Product Identification - **smarty**

The **smarty dw24X** Series Universal Automation Controllers (**UAC**) consist of a "Cassette" computer module mounted into a "Carrier" wiring module that provides field wiring for inputs and outputs, serial ports, expansion ports, and a battery holder.

Find **smarty** cassette model and firmware version. Use **savvy, Get Detailed Info** from **smarty** contextual menu. See page 6.



Warning! Avoid permanent damage to **smarty**. Disconnect all power sources prior to inserting or removing the cassette.

Product Identification - Part Numbers

Model number **dw24x** is appended with a two or six character extension.

Example; **dw240-DM-C4CD**

Cassette Model Mounting Type
 Cassette Build Standard D=DINrail, F=Foot, A=Spacer
 ModbusRTU Type Terminal Type
 C=Clamp, S=Screw, P=Plug-in
 Carrier Type

smarty Cassette Models

dw240 Universal Automation Controller, (**UAC**).

dw241 Basic automation controller for carrier **C1** only.

dw244 **UAC** for **P2** industrial vector drive.

dw248 **UAC** for **E3** open-loop vector drive.

dw249 **UAC** for **CANopen** server devices.

Standard Builds **A, B, C, and D** - Software Options

A=04 and 26, **B** adds 05 and 25, **C** adds 06 and 39, **D** adds 10 and 29.

04 ModbusTCP/IP - Slave/server. See page 12.

05 Process Control - Recommended for most applications.

06 Winder Control - Diameter Calc., Taper Tension, Torque Comp.

10 Math - With advanced math functions.

25 EIP/PCCC - Slave/server. See page 12.

26 savvyPanel - Operator station interface. See pages 8, 9.

29 Solar - Calculates sun position azimuth and zenith.

39 Precision Motion - With event, length, position, shaft-lock, indexing, motion control, cam profile, and more. Page 16.

smarty Installation

smarty is designed for permanent installation by qualified professionals. Install **smarty** in metal enclosure with no RF noise source.

DIN rail mounting - Use 35x7.5mm rail per IEC 60715 or EN50022.

Environment - UL/IEC Pollution Degree 2.

Operating temperature, 0°C min., 40°C max.

Storage temperature, -20°C to 50°C.

Altitude 3000m max.

Humidity 95% max. non-condensing.

Clearances must be provided around cassette to promote airflow, 25mm (1").

smarty Terminal Naming and Ratings

- Terminal names are consistent in the **drive.web savvy** software, on the terminal, and on the carrier.

24VDC and 0V Terminals are internally connected.

Regulated DC Supply, 25.2V_{max}, 22.8V_{min}, 1A.

External 1A fast-acting fuse or current-limiting is required!

Do not connect to a distributed DC power network.

Supply from Class 2, LPS, limited power supply, from within the same electrical enclosure, only.

AI - Analog inputs. -11VDC to +30VDC, 100kΩ, 1kHz.

AO - Analog outputs. **du241** is unipolar, ~0.2VDC to 10.5VDC, 10mA. All others are bipolar, -10.5VDC to +10.5VDC.

DI - Digital inputs. 50VDC_{max}, 8VDC threshold, 3V hysteresis. 1kHz.

DO - Digital outputs. 24VDC source, up to 80mA, shared. Resistive, general use, and pilot duty. Overcurrent protection and software indication. Maximum Voltage is 25.2VDC.

1A+ - Example: Encoder 1 Channel A+. Differential, incremental, quadrature encoder input. 24VDC max, -0.5VDC min., 0.3VDC minimum differential Voltage. Up to 1MHz.

FI - Frequency/event/digital input. 30V_{max}, 100kHz.

TO - Timing/Frequency/stepper/digital sinking output. 80mA shared, 30VDC max., 500kHz max. 10kΩ pull-up to **TPWR** (+5VDC for **FT** terminals and **C5**. **C5 TO** are 5VDC max.).

Caution! **TO** are sinking outputs without internal over-current protection. The installing engineer must assess the risk of overload and provide external protection to avoid damage to the unit, depending on the installation.

FT - Combined **FI** and **TO**, 5VDC max.

CI - Current Input. 100Ω input impedance. Maximum input is 25mA, 2.5VDC.

TPWR - Timing output pull-up source. 30VDC.

+5V Power supply outputs for use with encoders, sensors, and the **TPWR** terminal.

Maximum total current output is 80mA.

485+ - Example: ModbusRTU serial port non-inverting pin, 'B'.

smarty Terminals and Wiring

C1 thru C4 Terminal wiring - Strip 7mm(0.28”) or use ferrules. Use 0.08mm² (AWG28) minimum. One bare wire, 2.5mm² (AWG14) max. Two wires, 0.8mm²(AWG18) max. One wire with ferrule, 1.5mm² (AWG16) maximum.

C5 wiring is per contact type. Uses 24-position Molex Mini-Fit Jr. Housing 5557.

C6 Terminal Wiring - Strip 7mm(0.28”). 1.5mm² (AWG16) max. One wire with ferrule, 0.8mm² (AWG18) maximum.

Use shielded cable for runs over 30 meters.

Fast transient over-Voltage 1kV per EN 61000-4-4.

Signal Wiring Notes

Use twisted-pair wiring for encoder and serial differential signals.

- Outside metal enclosure, use shielded cable with individually shielded twisted-pairs such as **Belden 8163**. Ground shield at one end with a 360° ground clamp where cable enters “quiet” metal enclosure.
- Separate wiring from AC power cables or RF noise sources.

smarty Cassette Front Panel

USB port - Peripheral-type USB-C jack. Can be used for backup power to maintain the real-time clock.



Ethernet port - MDI 8P8C, “RJ45” jack, 100baseTX and 10BaseT, Full Duplex, Auto Negotiation, Auto-MDIX, IEEE 802.3ab.

Indicator LEDs in front panel:

 **Status** - Blue LED. Status heartbeat pulses twice a second.

 **Fault** - Red LED indicates a fault. Check power supply, connect with **savvy**, or contact us at **drive.web** for more info.

 **Ethernet link/activity** - Orange LED indicates Ethernet connection and blinks for activity.

 **100BaseTX** - Green LED when 100BaseTX connection is made.

smarty DRIVE Serial Port

- 8P8C RJ45 Socket
- ModbusRTU EIA485. See page 12.
- CANbus connection for **dw244**, **dw248**, and **dw249**. See page 12. 1m max. cable length. Do not add termination resistors. These are built-in.

1 2 3 4 5 6 7 8

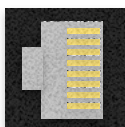
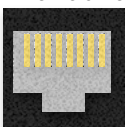

1 CAN-
2 CAN+
3 0V
4 No Connection
5 No Connection
6 No Connection
7 NC, Modbus-, A, C2 Only
8 NC, Modbus+, B, C2 Only

smarty C1 Carrier 1 (dw241 only)

- **drive.web** distributed process control.
- 10BaseT / 100baseTX Ethernet. See page 4.
- USB peripheral, micro B.
- Eight bipolar analog inputs.
- Eight unipolar analog outputs. Can be used as reference Voltage.
- Eight digital inputs. Can be used as event inputs. Page 5.
- Eight digital outputs: Overcurrent protection and software indication.
- Extra terminals for cabinet-side power; +24VDC, 0V.

smarty C2 Carrier 2 adds to C1

- Battery holder for real-time clock: CR2032. Battery not included.
- Bipolar analog outputs replace unipolar.
- **DRIVE** CANopen and ModbusRTU serial ports jack.

smarty C3 Carrier 3 adds to C2

- Four **FT** frequency/timing channels, multi-function; Frequency/event/digital input. Frequency/stepper/digital output, 5V sinking.
- Differential, incremental, quadrature encoder input.
- ModbusRTU serial port is brought out to terminals instead of the jack in **C2**.

smarty C4 Carrier 4 adds to C3

- Two 4-20mA current inputs. Also 0-20mA, 20-4mA, and 20-0mA. 100Ω input impedance.
- Six frequency/event/digital inputs, 100kHz max. Replaces **FT** on **C3**.
- Seven frequency/stepper/digital outputs, sinking with connectable **TPWR** pull-up rail. 500kHz max. Replaces **FT** on **C3**.
- Two differential, incremental, quadrature encoder inputs with markers, ABZ. Replaces single, A, B, encoder input on **C3**.
- Encoder 1, 2; A, B, reconnect terminals.

smarty C5 Carrier 5

- Three 24-position Molex "Mini-Fit Jr" headers in lieu of terminals for ultra-small form factor and easy, plug-in wiring.
- All features of **C4** except there are no encoder reconnect terminals and Frequency Inputs **F11** thru 5 and Timing Outputs **TO1** thru 5 are combined **FT** type as in **C3**, 5V max. **F16** is 30V max. **TO6**, **TO7** are 5VDC-supplied internally, 5VDC max.

smarty C6 Carrier 6

- Compact DINrail enclosure, only 1.05" wide!
- All features of **C4** except no encoder reconnect terminals.

Carrier C1, C2, C3, C4, C5 Side View

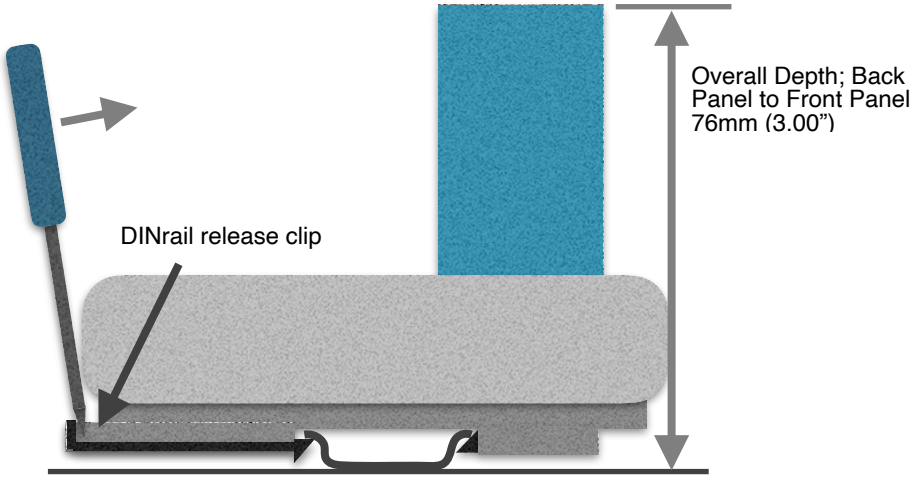

Carriers C1 and C2 Terminals and Dimensions

DRIVE 8P8C CANopen and ModbusRTU Serial Ports; **C2** Only

Clock Battery, CR2032 (Not included) **C2** Only

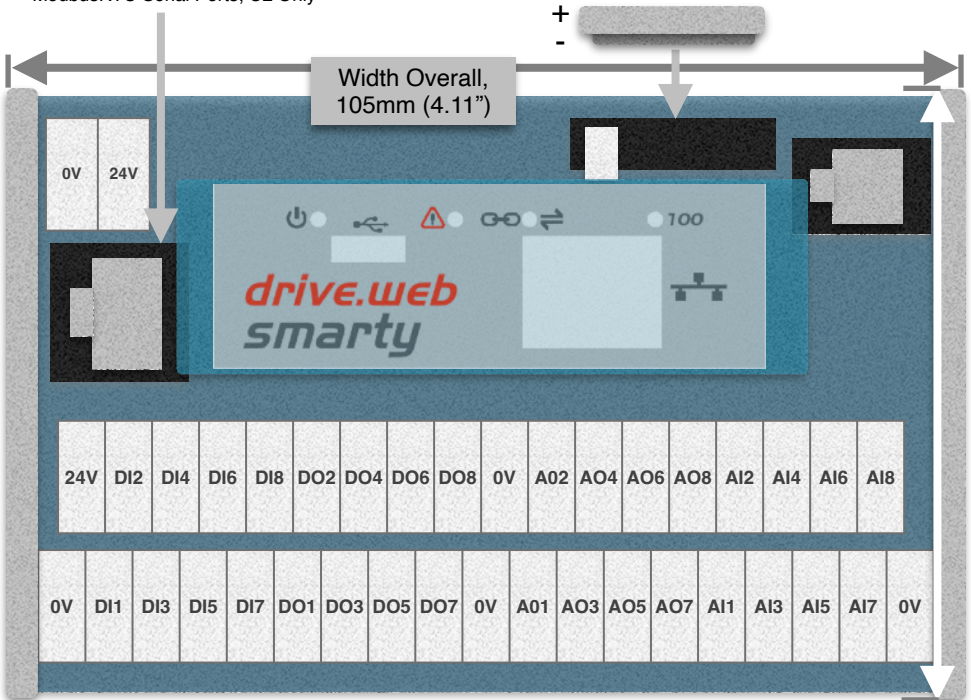

Height Overall, 89mm (3.5")

Carrier C3 Terminals and Dimensions

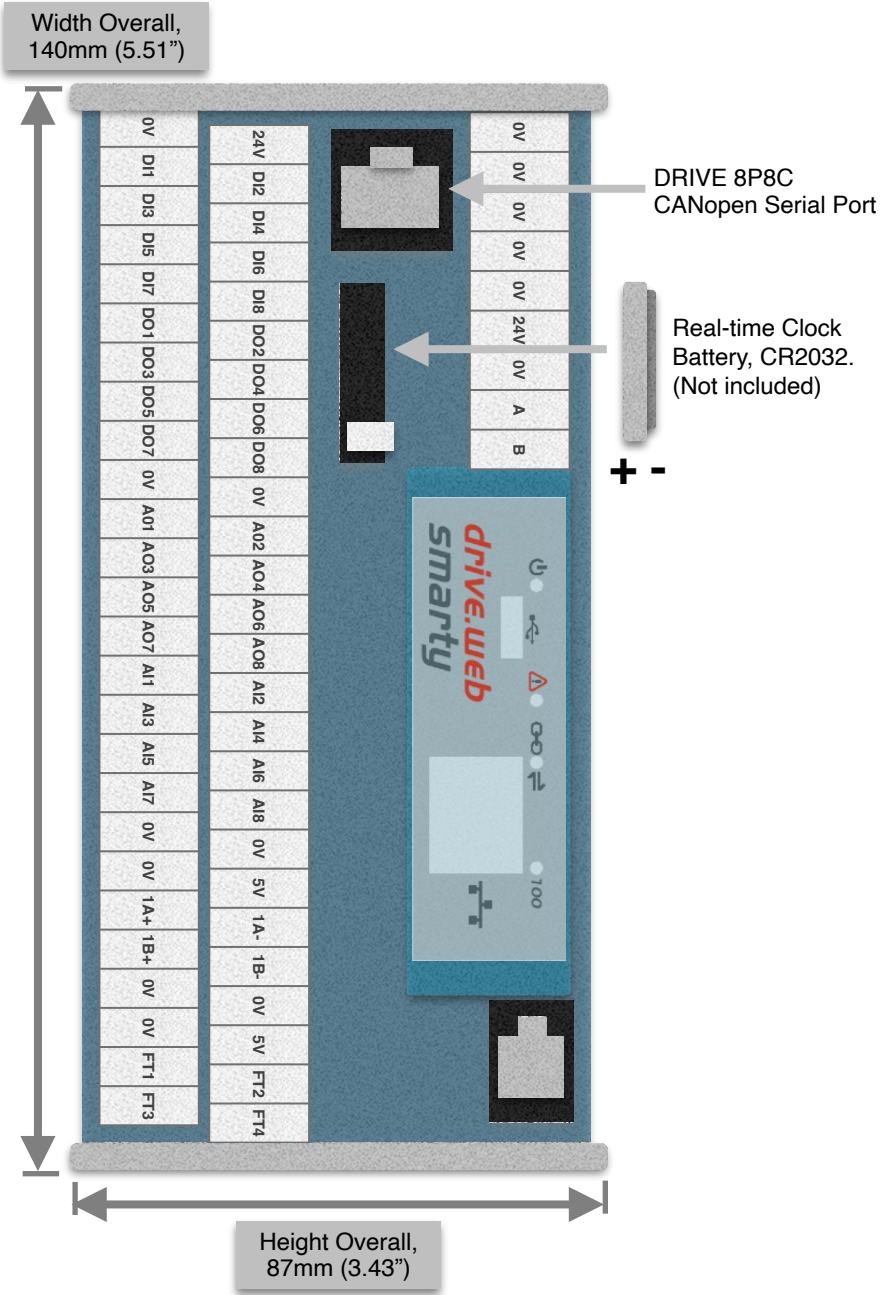

Carrier C4 Terminals and Dimensions

DRIVE 8P8C
CANopen Serial Port

Real-time Clock
Battery, CR2032.
(Not included)

+ -

Width Overall,
210mm (8.27")

Height Overall,
89mm (3.5")

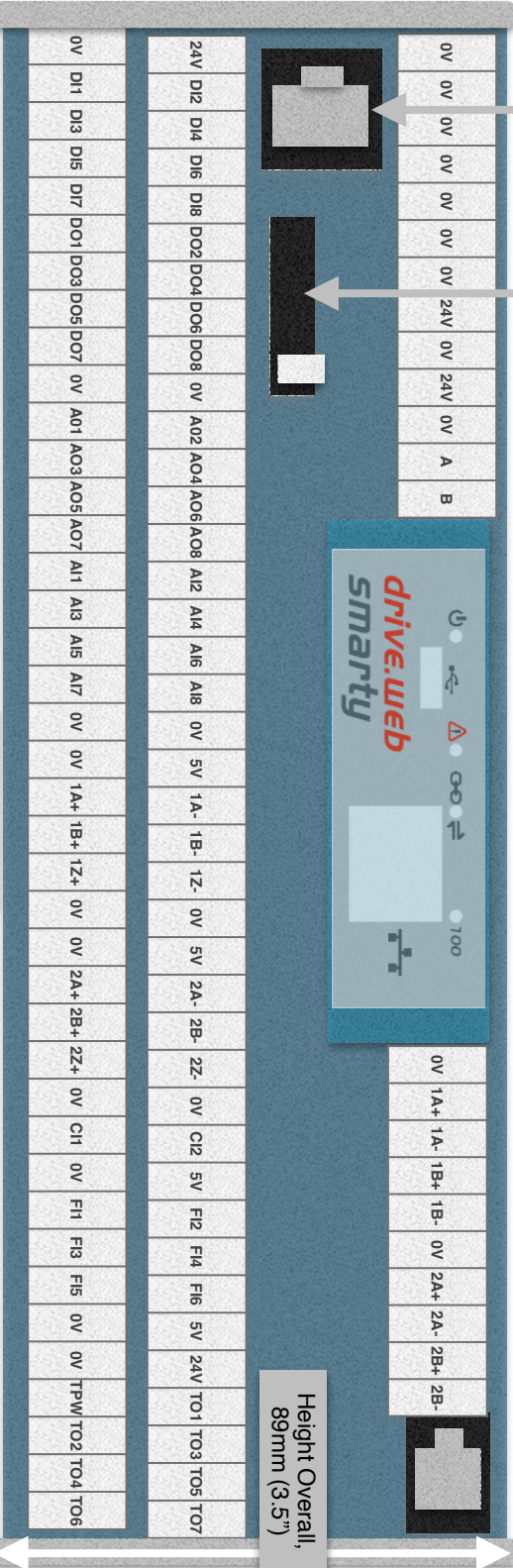

Carrier C5 Plug-In

Connectors and Dimensions

Spacer Mounting is pictured with hole locations. Four spacers have clearance for M3 or #6 screws.

Overall Dims.	Width	Height	Depth
Spacer Mount	90mm (3.54")	73mm (2.87")	55mm (2.16")
DINrail	92mm (3.62")	89mm (3.50")	76mm (3.00")

J9

DO2	DO4	+24V	0V	485A	0V	C11	0V	A17	A15	A13	A11
DO1	DO3	+24V	0V	485B	0V	C12	0V	A18	A16	A14	A12

J8

DO6	DO8	+24V	AO7	AO5	AO3	AO1	0V	DI7	DI5	DI3	DI1
DO5	DO7	0V	AO8	AO6	AO4	AO2	0V	DI8	DI6	DI4	DI2

Clock battery CR2032
(Not included)

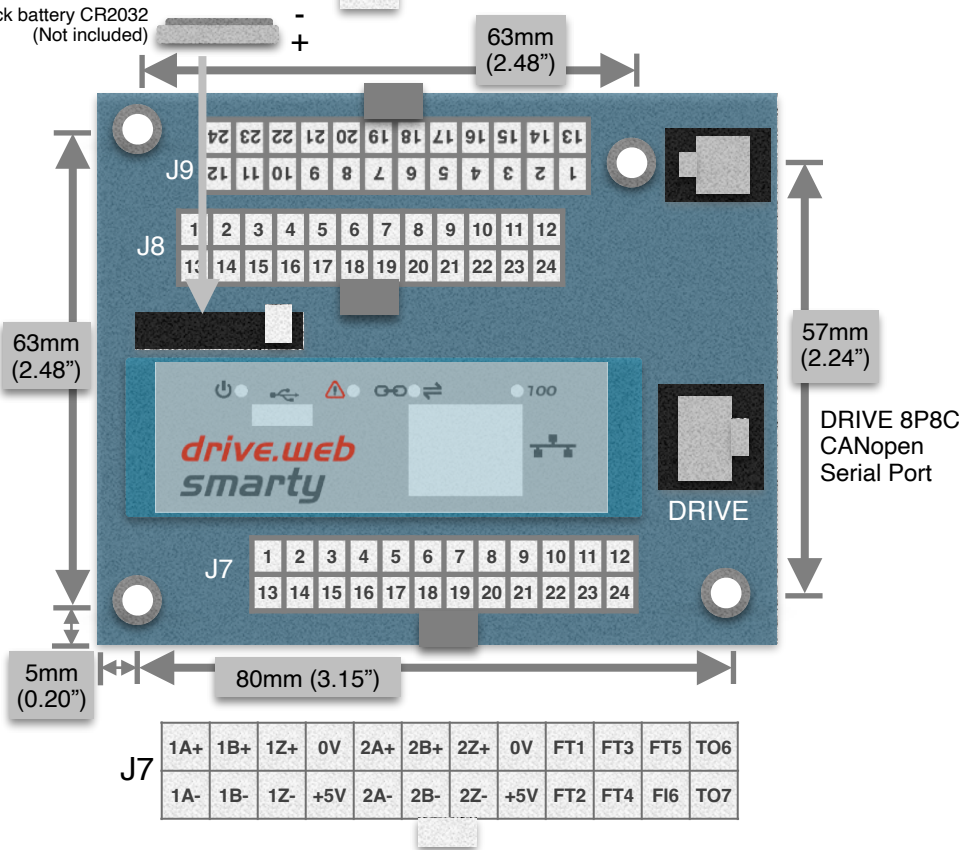

Carrier C6 Compact DINrail Terminals and Dimensions

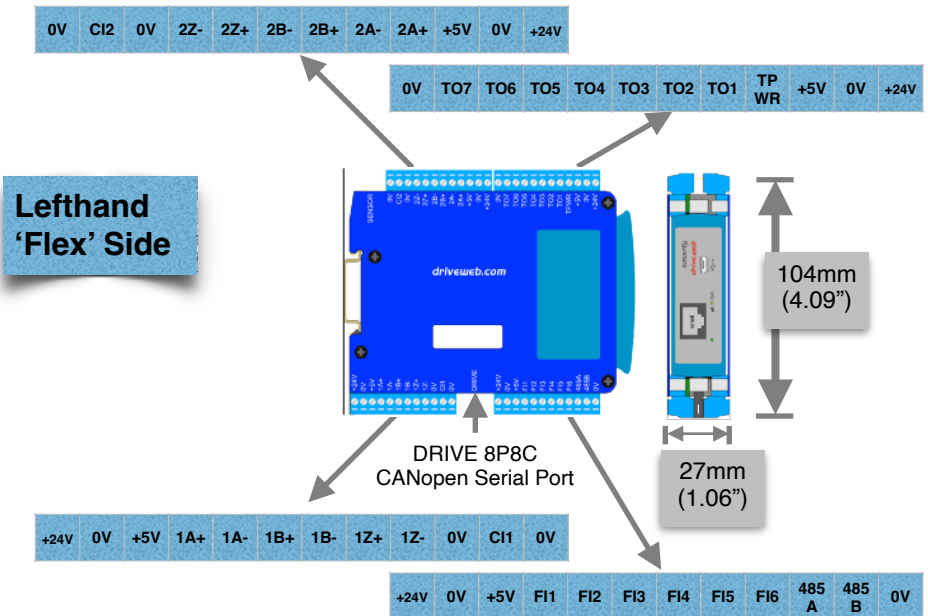
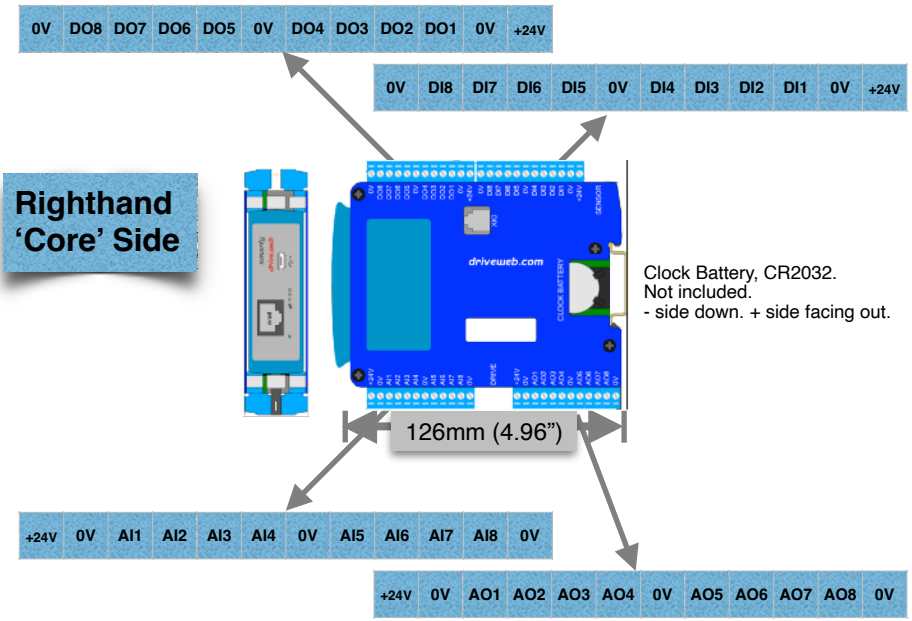

smarty Expanded Operating Ranges

Ratings specified on page 3 and 4 are limited by internal heating or possible interference-causing emissions when the 5V supply output is greater than 125mA. Use forced-air for expanded operating ranges (not UL tested). Ensure that **System Temperature**, parameter 4103, does not exceed 85C.

Environment - Expanded operating temperature, 0°C min., 50°C max. (not UL tested).

DO - Digital outputs. 24VDC source, expanded up to 300mA, shared. (not UL tested)

TO - Frequency/stepper/digital sinking output. Expanded to 300mA shared, 30VDC max. (not UL tested)

+5V Power supply output. Expanded current output is 300mA. The installer must ensure compliance with FCC part 15 rules on page 1; ‘the device must not cause harmful interference’. (not UL tested)

smarty Real-time Clock

- The real-time clock is only used for time of day and calendar functions. The clock can be set automatically upon discovery in the **drive.web savvy** software, per preferences. SNTP network time server protocol is supported. See the **savvy** user manual for details.
- The real-time clock will be maintained for approximately 24hrs after supply power loss with no backup battery. Alternatively the clock can be powered by the USB port.
- Lithium button cell battery, CR2032, 3VDC, commonly found in convenience stores, is not provided from the factory due to shipping restrictions.

smarty Frequency Input Notes (FI Terminals)

FI Digital and Event Input Function Blocks

- Maximum event frequency is $1/(2 * \text{FBE cycle (s)})$ Hz. E.g., for 5ms FBE cycle, the max event frequency is $1/10\text{ms} = 100\text{Hz}$.
- Use **Digital Input** function block **Input Type** parameter to configure;
 - Pull-Down = 2VDC (1.2Vmin, 2.9Vmax)
 - Pull-Up = 1.2VDC (0.5Vmin, 1.9Vmax)

FI Counter Inputs - Provide frequency data with adjustable moving-average filter and count outputs for use with motion control function blocks.

FI Frequency Inputs - Useful for lower frequencies $\sim < 10\text{kHz}$. Duty cycle is also measured. Updates every FBE cycle or two-edge cycle.

smarty Programming

Set up your computer - Get *savvy*

With free **drive.web savvy** software, easily program and monitor your **smarty**, perform data trending, and create distributed control systems.

- Go to www.driveweb.com and click on **Get savvy**, or contact us to get the latest version of **savvy**.

smarty USB - Plug and Play

Plug-and-play access to **smarty** and its local Ethernet network.

smarty Ethernet Networking & Programming

Assigning an invalid or duplicate IP address will cause serious network malfunctions!

- Find useful networking information. Under the **Help** menu click on **Getting Started with savvy** section.
- **smarty**s are shipped with an IP address, 10.189.x.x, derived from the serial number. The six-octet serial number always starts with 0-4-bb-x. The last two octets are used to assign the as-shipped IP address; Example, if the serial number is 0-4-bb-00-1a-2b, 1a is converted from hexadecimal to decimal, 26. 2b, similarly, is 43, decimal. The as-shipped address is 10.189.26.43.
- Use *Category 5e* cable or better, with 8P8C/RJ-45 connectors for each **drive.web** device and the host computer.
- For systems with more than one **drive.web** device, use an Ethernet switch for all **drive.web** devices and computer.



Get started with *savvy*

- We strongly recommend attending our free online training seminars. See page 16.
- We strongly recommend you read the **User Manual** and **Getting Started Guides** under the **Help** menu.
- Use **Create Phantom** in the **Directory** menu to explore **drive.web** products and options, design, and configure offline. **Export Data** to save your work. **Import Data** into phantoms to work offline.

savvy Window Title Bar indicates the current view.

Status Bar, above the viewing area, provides **Navigation Arrows** and object and location data.

- **savvy** views are hierarchical with the **Device Directory View** at top. Use the **Navigation Arrows** to go up, back, or forward. Window menus change as you navigate.

Hover cursor over active object, device, function block, connection, or parameter icon to view object information in the **Status Bar** and reveal a **Hover Button**.

Click a Hover Button or right-click an active object to access a **Contextual Menu**. See below.

savvy functions are limited by password-protected capability level. See **File > Capability...**

Device Directory Window

Warning! Changing a device IP address **WILL** disrupt its network connections! If a **smarty** is communicating with other devices, be prepared for system disruption. In the **File** menu choose **Utility > Remap Export File** to remap a **dw-system** file with different IP address(es).



- Select **File>Administrate>Set IP Addresses for System**.
- **smarty** serial number is also its **MAC Address**.
- Enter a valid IP address and click OK.
- An icon appears with IP address beneath. Drive-dedicated models depict the actual frame size of the drive.
- If the icon at right appears, a network connection problem exists. Check connections, LEDs, and that the **smarty** IP address is within the computer's Ethernet subnet mask.



10.189.189.189

Warning! Importing data into your **smarty** will result in immediate execution of that configuration. **Dangerous Voltages and rotating machinery may result!** Use a phantom to preview a configuration.



- **Directory > Import / Export Data**. All device configurations and connections in the directory in one **.dw-system** file.

smarty Icon Contextual Menu

- **Change Name** - Name your **smarty** for easy identification.
- **Import / Export Device Data...** - Load / save configuration data to / from this **smarty** only.
- **Unlock, Lock, Set Password** - Choose **Restrict Modification** to allow viewing the configuration, or **Restrict All Access**.



Controls Motion



Controls Motion

Click the **smarty icon** to view the device configuration.

Function Block Engine Window - FBE Menu

(Standard **savvy**, no **SFD**)

- Add function blocks in the order to be processed. Processing order is left to right, top to bottom.

Click **function blocks** to view parameters and details.

Connect between parameters and other **drive.web** devices.

Warning! Making a connection results in immediate execution of that connection. **Dangerous Voltages and rotating machinery may result!**



- Under the **File** menu, choose **New Viewer...** and then, **File > Open Device Directory**.
- With two viewer windows, click a parameter, drag and drop onto a parameter in the other viewer.

Parameter Contextual Menu - Data is formatted, limited, and scaled depending on the parameter. Use **Get Info** or **Re-Scale...** to verify or change.

Click **parameters for the Setter Box** - Increment, decrement, default, last state, or keyboard entry.



Click **blue connection block or arrow** to jump to other end.

Upgrade **savvy** and **smarty**

Upgrade **savvy** with **SFD Signal Flow Diagram**.

Upgrade **smarty** with software options.

Process credit cards or **Vouchers** online or **Coupons** offline.

- To upgrade **savvy**, go to the **Commerce** menu, select **Upgrade savvy**, check desired options, click OK.
- To upgrade **smarty**, choose **Upgrade Device...** in its contextual menu, check desired options, click OK.
- To process **Vouchers**, choose **Pay > Online Via Vouchers** in the **Shopping Cart**. Enter **Voucher** codes on separate lines.
- To process **Coupons**, go to the **Commerce** menu and choose **Coupon Manager**. Enter codes in the top box and click the **Add** button and the coupon is recognized. Click **Apply**.

savvy-SFD Signal Flow Diagram Upgrade

- With **savvy-SFD**, build systems graphically. The live drawings are stored in your **smarty**.
- Set drawing borders and annotate multi-page drawings.
- A filterable list of function blocks and connections is at the left of the **Signal Flow Diagram** showing **program execution order** from top down. Change execution order by dragging function blocks up or down the list. In this picture, **ENC1 Speed** function block is moved so that it is processed after **ENC Phase Lock**.

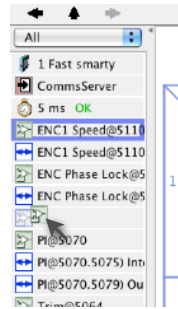

savvyPanel Operator Station

Computers, Apple®, and Android™ mobile digital devices are operator touch stations with **savvyPanel**. Requires Windows, Mac OS X, Linux-based Ubuntu, Android, or iOS®.

- Configurations are stored in the **drive.web** devices.
- **savvy-SFD** upgrade is required to edit or build **savvyPanel** systems.
- **dwOption-26 savvyPanel**, must be installed in **drive.web** devices to enable the full suite of tiles. A limited set is available without the option.

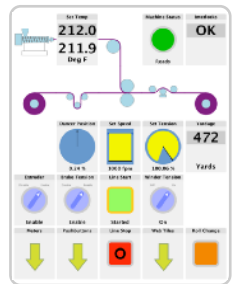



Get **savvyPanel** free from Apple App StoreSM and Google Play

- When your mobile digital device is connected to the internet via WiFi, demo mode connects to a live drive system in our plant in Maryland, USA.
- Explore the demo with **savvy**. Select **File > Demo Mode > Discover Internet Demo Devices**.

savvyPanel Pages

Systems Page where multiple **savvyPanel** systems are present.

- A **savvyPanel** system may contain tiles from many **drive.web** devices.
- A **drive.web** device contributes to only one **savvyPanel** system.
- Touch the systems button,  or , in the window bar to access the systems page from home page. Lock this button with home password.

Home Page is the first operator page in a **savvyPanel** system.

- Access home page from any operator page with the home button, . Lock with the home password.

Operator Pages show graphic, page-link, and parameter tiles.

- Pages can be renamed. Page name appears in window title bar.

savvyPanel Tiles

Parameter Tiles - Touch a settable parameter to set. Setter includes slider, keypad, 1x and 10x increment and decrement, return-to-default, and revert.

Graphic Tiles - Create diagrams with process elements.

Page-Link Tiles - A graphic tile that is also a page-link. Touch to change the view to that page.

Device Tiles - Link to device's signal flow diagram in Java-based **savvyPanel**. Appears as graphic tile in iOS.

Function blocks enable savvyPanel actions

Alarm Annunciator - Provides a system-wide alarm annunciation when active. Touch to view page 255.

Presence Monitor - Indicates the presence of a tagged **savvyPanel** application viewing a particular page.

Latch and **SR Latch** - For lighted start-stop pushbuttons.

Setpoint & Monitor - Adjust meter and setter range. Dual blocks enable dual-display meters.

Enumerated Parameter - In **Utility** group. Only custom enumerations appear in the setter and multi-position switch.

savvyPanel Launch, Setup, and Important Notes

- See the **savvy** user manual for detailed instructions.
- Launch **savvyPanel** via command line or batch file.
- Limit operators to **savvyPanel** only. Specify start system and page.
- Discover devices automatically, specifically by discovery file, or filtered by group and/or **savvyPanel** name.
- Operator's note: If communication with a **drive.web** device is interrupted, affected tiles indicate a yellow bar with a warning symbol. The tile is not updated.

Important Design Note - An over-range enumeration is required if an out-of-range value could cause a hazard.

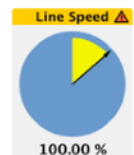
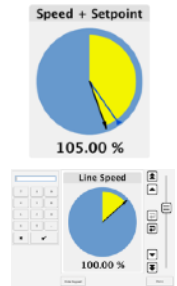

smarty Precision Motion Parameters, Connections

Special parameter and connection types from I/O function blocks.

Connections may also be over Ethernet to other **drive.web** devices without performance penalty.

- F** **Floating Point** - IEEE-754 Binary32, wider range and resolution. Can be connected to or from standard, 16-bit parameters; 1.0000 float equals 100.00%.
- E** **Event** - Events are associated with exact count values. Maximum event frequency is (1/(FBE Timebase seconds)) Hz. Only the first event is processed per FBE cycle.
- C** **Count** - Position applications; shaft-lock, registration, motion control, etc. 64-bit internal values, precision timing data.

smarty Comms Interfaces-CANopen, Modbus, EIP/PCCC



Warning! Use of **smarty** comms interfaces may cause motors and machinery to energize with high Voltages, or start, or operate in unexpected, dangerous, or lethal ways.



- For Modbus specs go to <http://modbus.org/specs.php>

smarty Comms Server *dwOption-04* and *-25*

- **Note!** You cannot write or force parameters that are read-only or have incoming **drive.web** connections.
- Click the **Comms Server** icon in the **FBE** or **SFD** view.

dwOption-04 ModbusTCP/IP slave/server

- Supported Modbus Function Codes; 1 thru 6, 15, and 16.
- Supports up to **five simultaneous clients/masters**.

dwOption-25 EIP/PCCC Server

- Supports PLC5 Typed-Write and Typed-Read commands.
- See Appendix B of the **savvy** User Manual for information and **drive.web** parameter IDs mapping to PLC5.
- Supports up to **two simultaneous clients**.

ModbusRTU Type (not available in C1)

M=Master-Client, **S**=Slave-Server, **X**=None-e.g. **dw247**.

- Modbus Function Codes **FC 01** through **06** and **16** are supported. Also special Yaskawa Holding Register.
- Each server's Modbus address must be unique on the network!
- All devices on the network must have the same baud rate, up to 500.0kbps, and the same character framing.

dw249 Generic CANopen Master

- Dedicated to a single server device at speeds up to 1Mbps.
- 1m max cable length.
- Do not use termination resistors. These are built-in.
- Use **CANopen Setup** function block to configure.

drive.web Training Courses

Free online interactive training seminars take about one hour. Specialized online and factory training sessions are also available.

To register email training@driveweb.com or call.

